

# 11.4m INTERCEPTOR

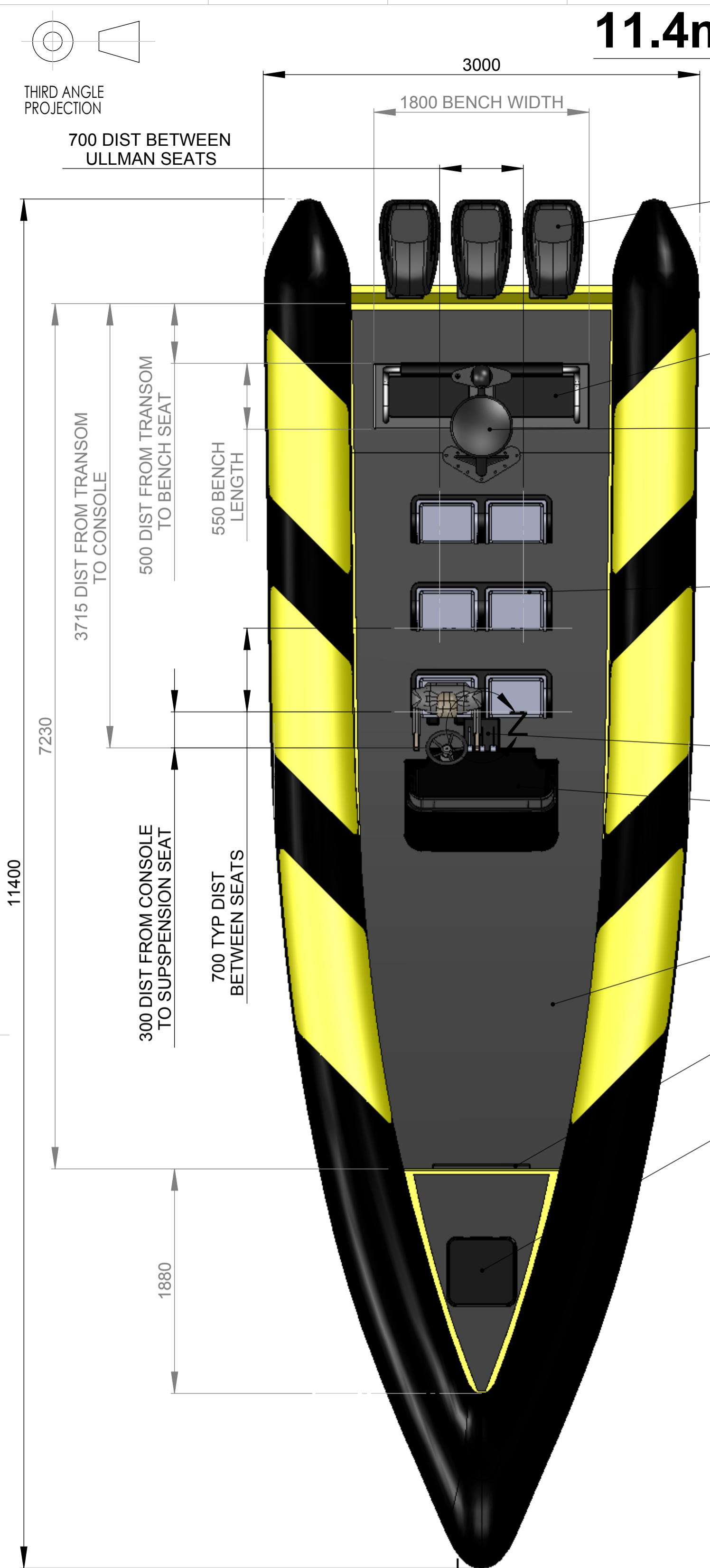

TRIPPLE MERCURY VERADO 350 OUTBOARD ENGINES

BENCH SEAT/STORAGE LOCKER

RADAR/LIGHTING/ARIEL POLE

4 x CARBON SUSPENSION LEAN BOLSTERS, POSITIONED AS DETAILED

MERCURY RACE LEVERS

RING CONSOLE MANUFACTURED FROM CARBON FIBRE, CENTRALISED AND POSITIONED AS DETAILED. SPRAY WINDSCREEN

ANTI-SLIP DECK

CARBON FIBRE 10 MAN LIFE RAFT

RAISED BOW WITH CARBON FIBRE HATCH ON TOP FACE

## CARBON MAST

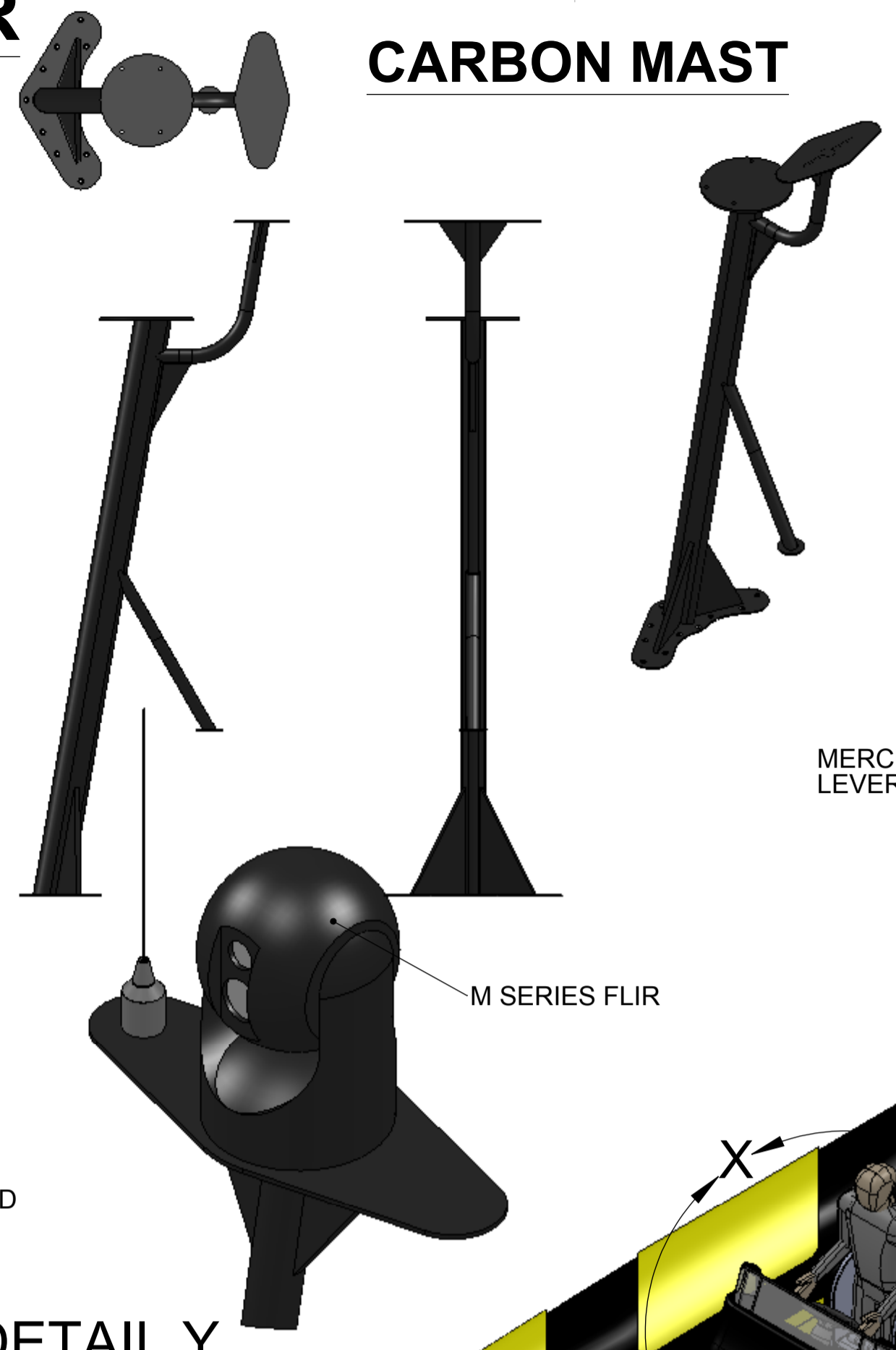

MERCURY RACE LEVERS

M SERIES FLIR

## DETAIL Y SCALE 1 : 5

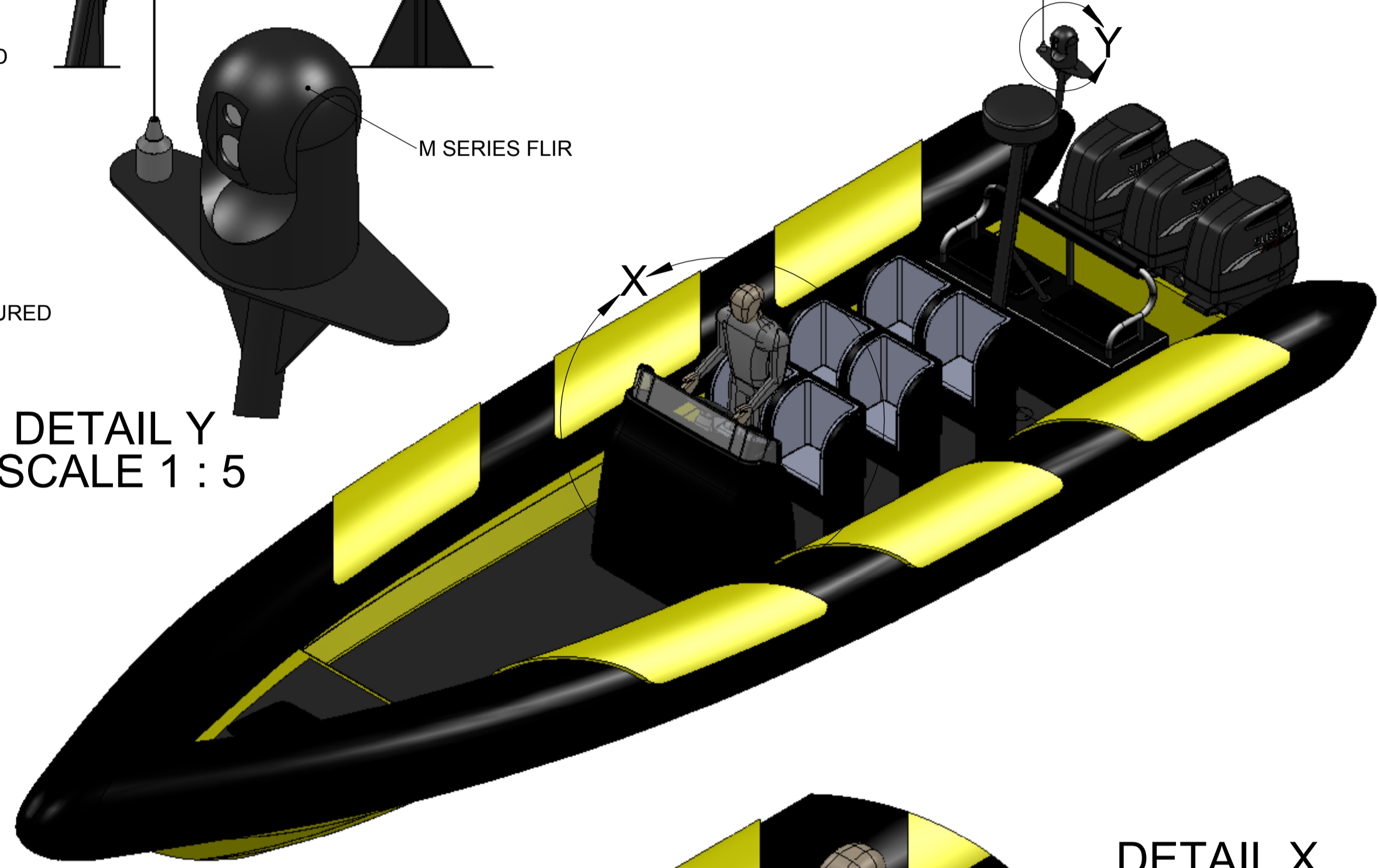

## DETAIL Z SCALE 1 : 5

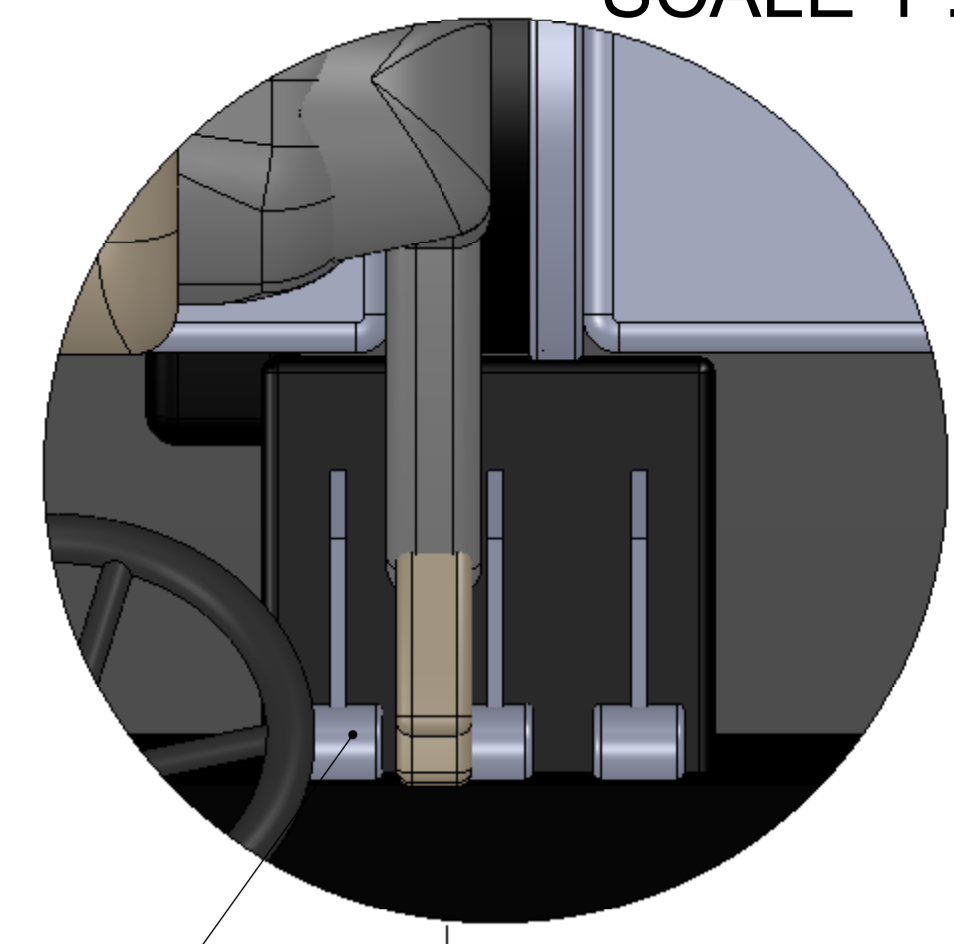

## DETAIL X SCALE 1 : 15

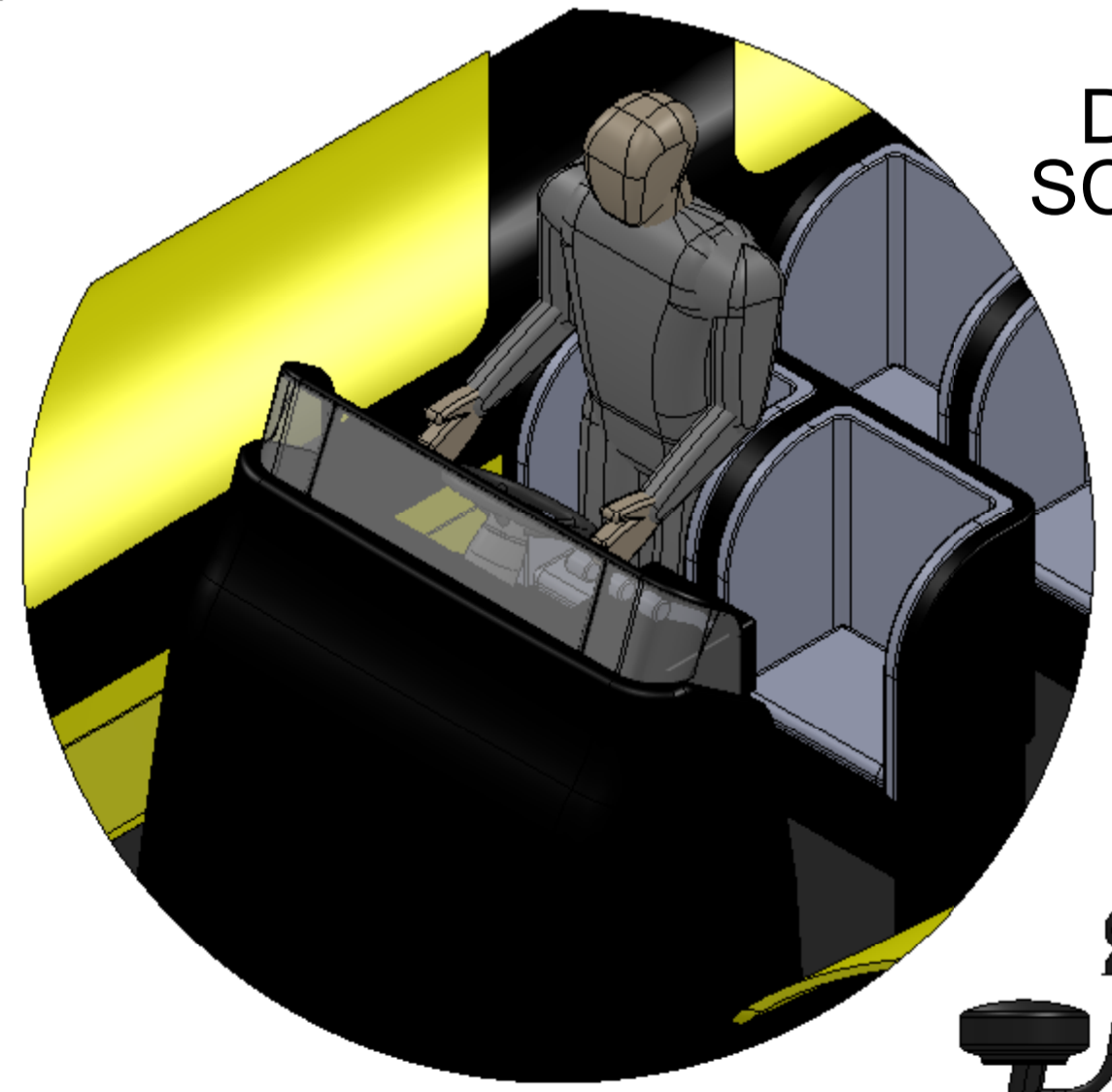

## CARBON SUSPENSION LEAN BOLSTER

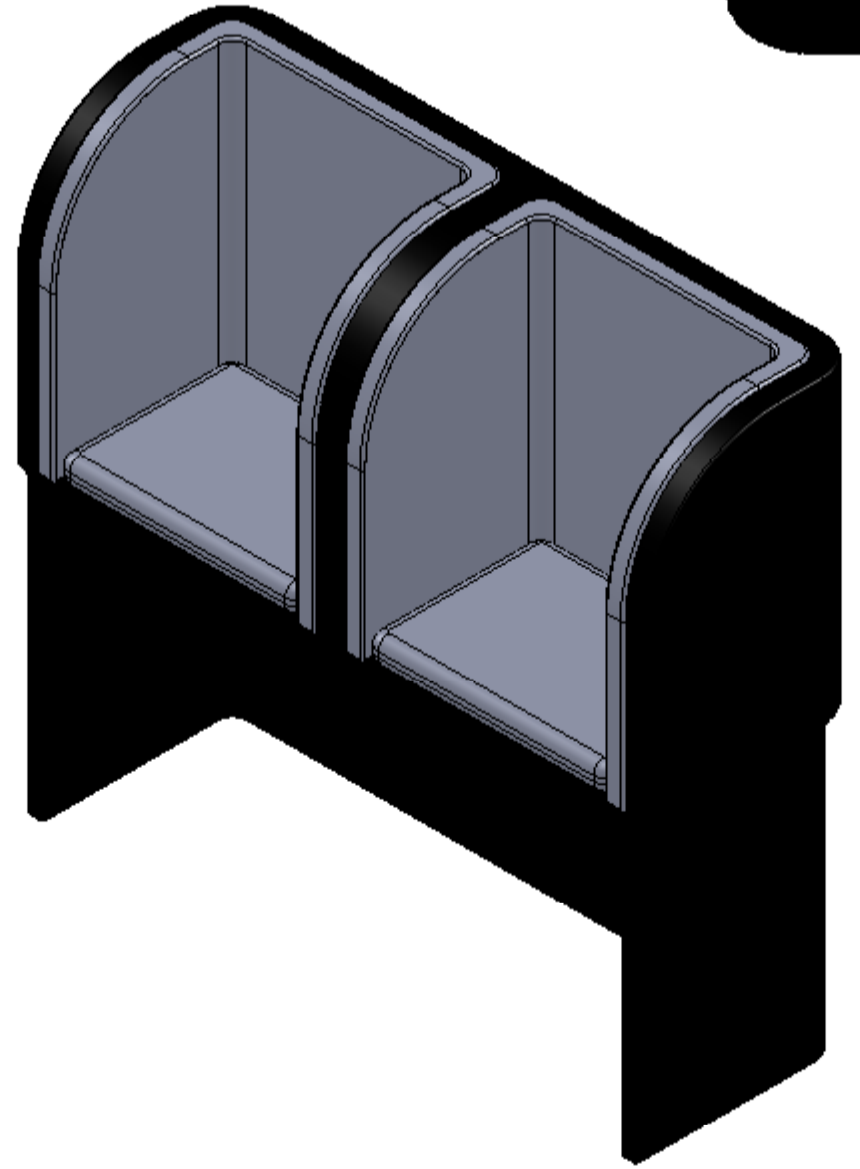

### NOTES

- HULL - BLACK
- DECK (ANTI-SLIP) - BLACK
- UPHOLSTERY - BLACK
- POD SEATS - CARBON FIBRE
- BENCH SEAT - BLACK
- CONSOLE - CARBON FIBRE
- TUBE - BLACK
- RUB STRIP - BLACK
- WEAR PADS - BLACK
- "D" RING TUBE PADS - BLACK
- ROPE - BLACK
- GRAB HANDLE - TBA
- BOW SNUBBER - TBA
- SELF RIGHTING BAG - N/A
- LOGO - Y/TBA
- ALL TUBE WORK IS BLACK POWDER COATED 316 GRADE STAINLESS STEEL
- 304 STAINLESS STEEL FUEL TANK MOUNTED UNDER DECK, SIZE TBA
- UNDER DECK TRUNKING FOR CABLES
- EXTRA'S - TBA
- TRAILER - TBA

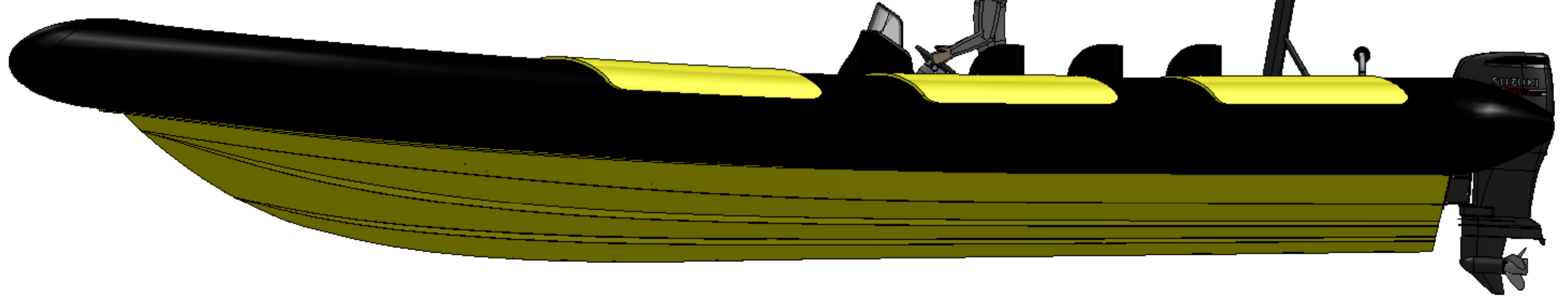
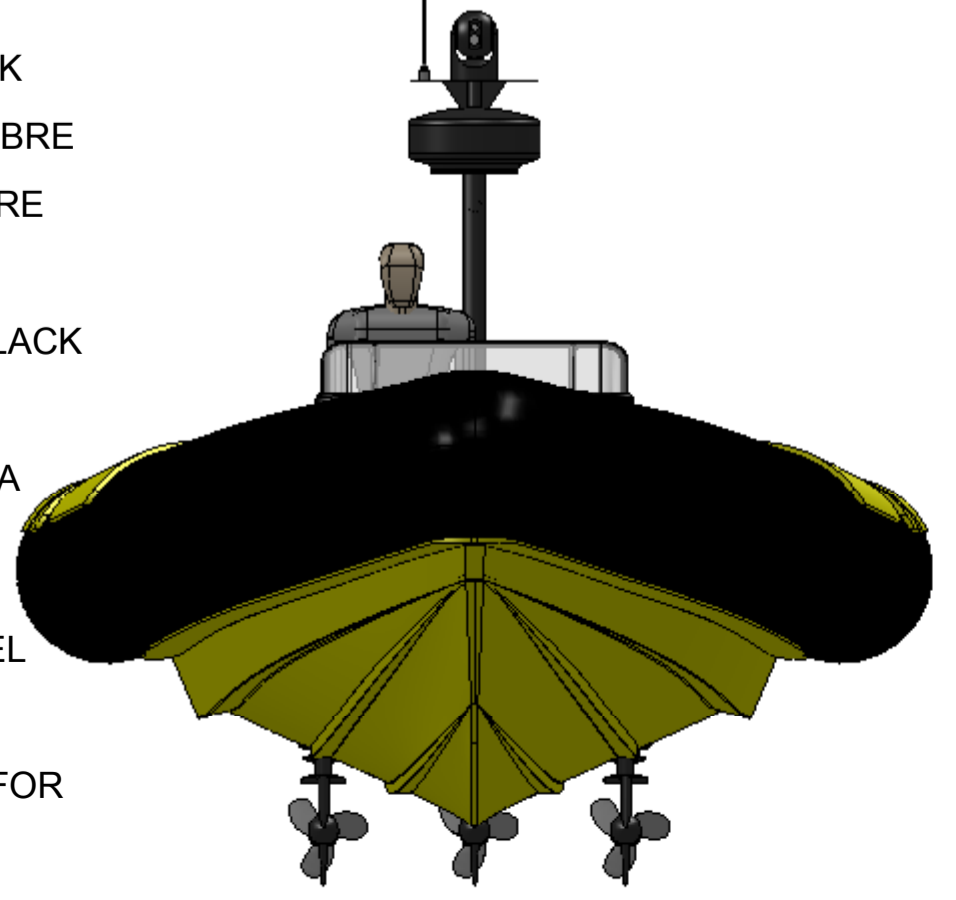

REVISIONS		
REV.	DESCRIPTION	DATE
1	FIRST ISSUE	23/09/2009

## CONSOLE SCREEN OPTION 1

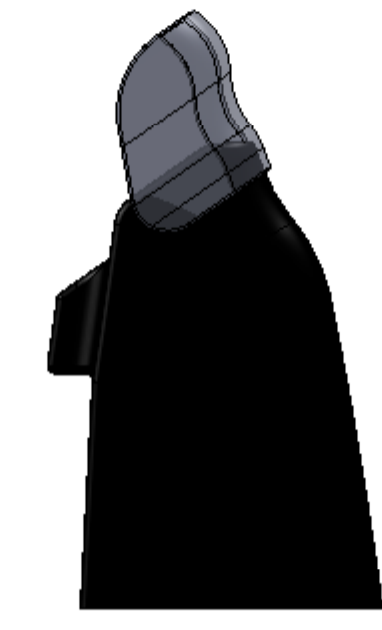
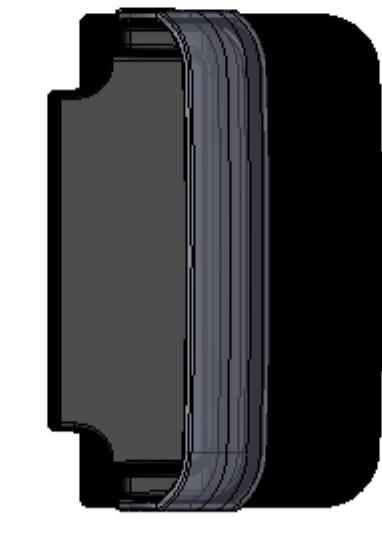

## CONSOLE SCREEN OPTION 2

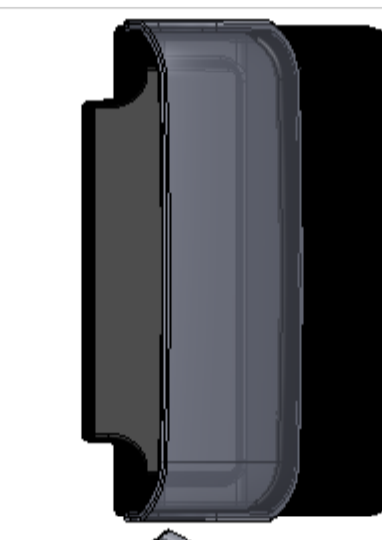

## CONSOLE SCREEN OPTION 3

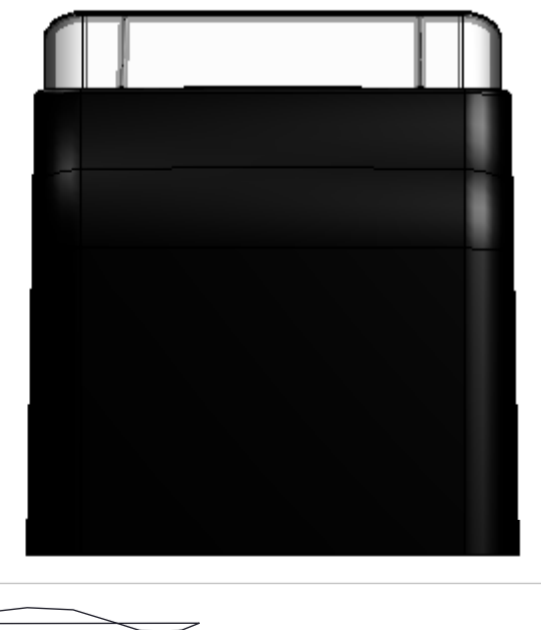
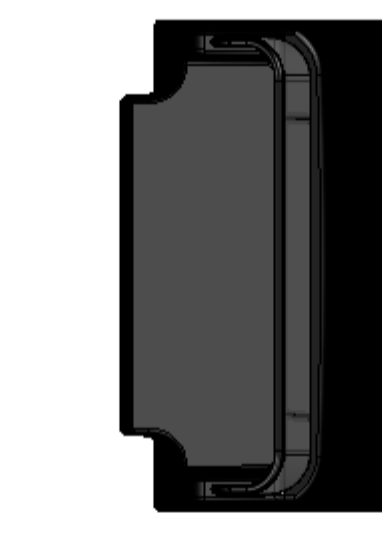

NAME	DATE	EDWARD CLOSE, HOUNDSTONE BUSINESS PARK
DRAWN	CDG	23/09/09
CHECKED		YEOVIL, SOMESSET, UK, BA22 8RU
APPVD		Tel : 01935 411 846, Web : www.ribcraft.co.uk
		email : sales@ribcraft.co.uk

GENERAL TOLERANCES UNLESS STATED OTHERWISE ALL DIMENSIONS ARE IN MILLIMETERS		TITLE : INTERCEPTOR	TENDER No. : -
LINEAR : ± 0.5mm	ANGULAR : ± 5 DEGREES	FINISH : -	CRAFT : 11.4m
SURFACE FINISH : -		MASS : -	STOCK CODE : -
SCALE: 1:30		DRG NO : RCL00135	SHEET 1 OF 1